

# INSTALLATION INSTRUCTION

## 417 - LED Outdoor

WS-W41716, WS-W41722

# WAC LIGHTING

Responsible Lighting®

### WARNING

IMPORTANT: NEVER attempt any work without shutting off the electricity.

- Read all instructions before installing.
- System is intended for installation by a qualified electrician in accordance with the National Electrical Code and local regulations.
- Go to the main fuse box, or circuit breaker. Place the main power switch in the "OFF" position and unscrew the fuse(s) or switch "OFF" the circuit breaker switch(es) that control the power to the fixture or room that you are working on.
- Place the wall switch in the "OFF" position.

### CAUTION

- All parts must be used as indicated in these instructions. Do not substitute any parts, leave parts out, or use any parts that are worn out or broken. Failure to follow this instruction could invalidate the ETL/CETL listing of this fixture.  
CAUTION When handling the fixture, do not apply pressure to the LEDs. Hold the fixture by the base only.

### AVERTISSEMENT

IMPORTANT : Coupez l'électricité avant TOUTE manipulation.

- Lisez toutes les instructions avant d'installer.
- Système est destiné à être installé par un électricien qualifié en conformité avec le code national de l'électricité et les règlements locaux.
- Accédez au panneau central de disjoncteurs ou de fusibles de votre demeure et placez l'interrupteur principal en position d'arrêt (« OFF »).
- Placez l'interrupteur mural en position d'arrêt (« OFF »).

### MISE EN GARDE

- Toutes les pièces doivent être utilisées tel qu'il est indiqué dans ces instructions. Ne remplacez pas les pièces, n'en laissez pas de côté et ne les utilisez pas si elles sont usées ou brisées. Le non-respect de ces instructions peut annuler l'homologation ETL/CETL du luminaire. MISE EN GARDE Ors de la manipulation de l'appareil, ne pas appliquer de pression à la LED, tenir l'appareil par la seule base.

### ADVERTENCIA









IMPORTANTE: NUNCA intente hacer trabajos sin desconectar el suministro eléctrico.

- Lea y comprenda todas las instrucciones e ilustraciones por completo antes de proceder con el ensamblaje e instalación de esta lámpara.
- Sistema está diseñado para ser instalado por un electricista calificado, de acuerdo con el código eléctrico nacional y las normas locales.
- Diríjase a la caja de fusibles o a la caja del interruptor de circuito principal en su hogar. Coloque el interruptor de alimentación principal en la posición "OFF" (APAGADO).
- Coloque el interruptor de la pared en la posición "OFF" (APAGADO).

### PRECAUCIÓN

- Todas las piezas deben usarse como lo indican estas instrucciones. No reemplace las piezas, no omita piezas durante la instalación ni utilice piezas gastadas o rotas. El incumplimiento de esta indicación podría invalidar la calificación ETL/CETL esta lámpara. PRECAUCIÓN Al manipular el aparato, no aplique presión a los LED, mantenga el aparato en la base sólo.

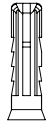
### HARDWARE

A1	B1	C1	D1	E1	F1	G1	H1	I1
								
Wire Connector Qty: 3 pcs +1 Extra 7EAC112201	Junction Box Screw Qty: 2 pcs +1 Extra 7MPF0825C1 #8-32x1 SS	Mounting Screw Qty: 1 Extra 4MPF0412S3BW (BZ) 5/32"-32x1/2 SS	Glass Screw Qty: 1 pc +1 Extra 4MPF040702BW (BZ)	Holder Screw Qty: 2 pcs +1 Extra 7MPF0308C4 1/8"-40x5/16 SS	Gasket Qty: 1 Extra 7TGD060301CL	Plastic Anchor Qty: 2 pcs +1 Extra 7TDD082401	Wood Screw Qty: 2 pcs +1 Extra 7MPF2204J2 Ø4x22	Silicone Washer Qty: 1 pc +1 Extra 7TGD130201CL

wacighting.com

Phone (800) 526.2588

Fax (800) 526.2585

Headquarters/Eastern Distribution Center

44 Harbor Park Drive

Port Washington, NY 11050

Central Distribution Center

1600 Distribution Ct

Lithia Springs, GA 30122

Western Distribution Center

1750 Archibald Avenue

Ontario, CA 91760



# INSTALLATION INSTRUCTION

## 417 - LED Outdoor

WS-W41716, WS-W41722

# WAC LIGHTING

Responsible Lighting®

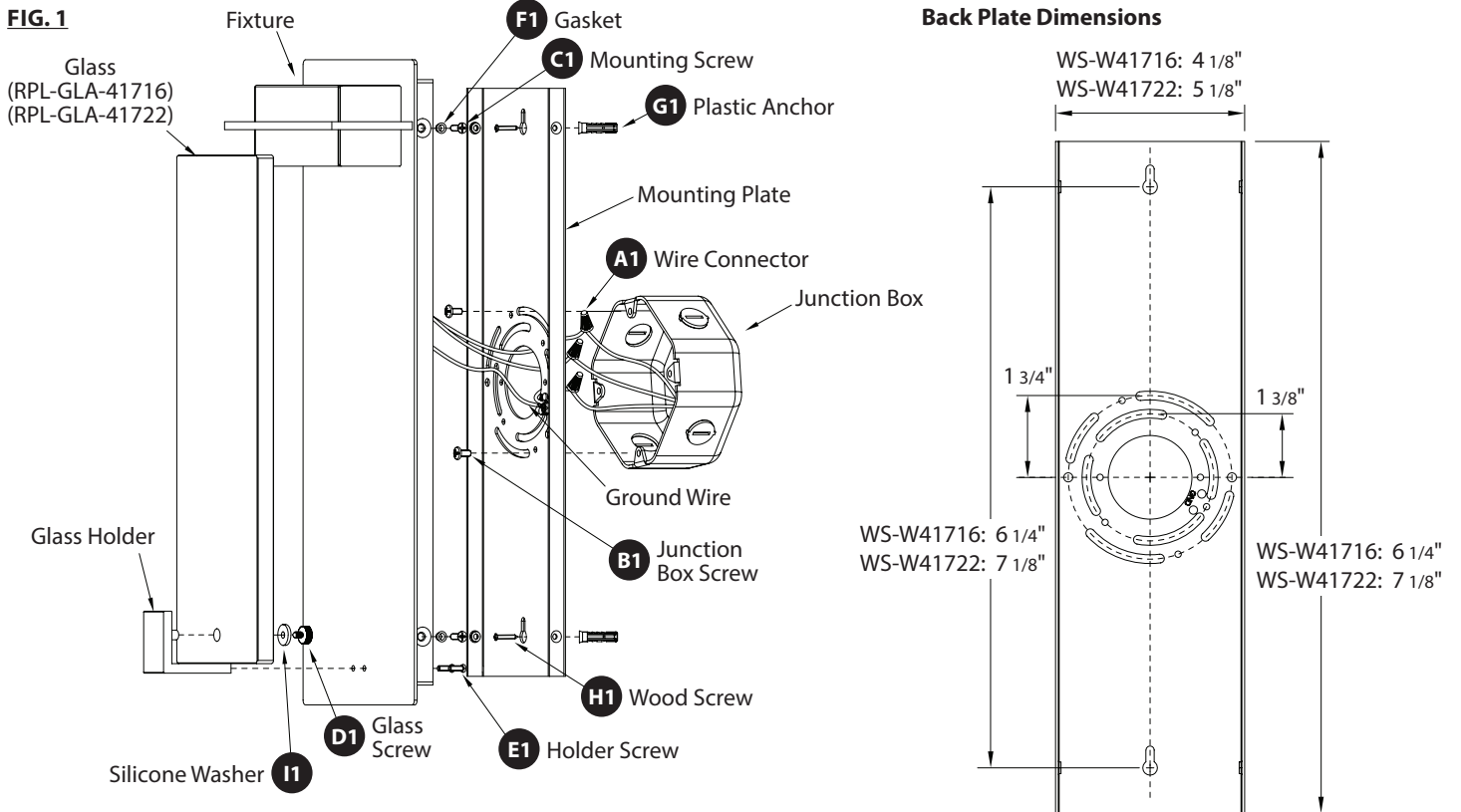

### PREPARATION

1. Shut off the power at the circuit breaker and remove existing fixture, including the crossbar.
2. Carefully unpack your new fixture and lay out all the parts on a clear area. Be careful not to lose any small parts necessary for installation.

### MOUNTING THE FIXTURE (Fig. 1)

3. Remove the mounting screws (C1) and the rubber gaskets (F1) from the fixture.
4. Place the glass on the glass holder, secure it with glass screw (D1) and silicone washer (I1), then fasten the glass holder to the fixture with holder screw (E1).
5. Drill holes in the wall aligned with the key holes located in mounting plate, insert the plastic anchor (G1).
6. Secure the mounting back plate to the junction box using junction box screws (B1), fasten it to the wall using wood screw (H1). The side of the mounting back plate marked "GND" must face out.

### CONNECTING THE WIRES (Fig. 2)

7. Connect the fixture's wires to junction box wires as shown in **Fig. 2**, making sure that all wire connectors (A1) are secured. If your outlet box has a green or bare copper ground wire, connect the fixture's ground wire to it. Otherwise, connect the fixture's ground wire directly to the back plate using the green screw provided. After wires are connected, tuck them carefully inside the junction box.
8. Secure the fixture to the mounting plate using the mounting screws (C1) and the rubber gaskets (F1).
9. To prevent moisture from entering the outlet box and causing a short, use clear caulking (i.e. indoor/outdoor silicone sealant) to outline the outside of fixture back plate where it meets the wall. Leave a space at the bottom to allow moisture to escape (**Fig. 3**).

### Fig. 2 Wiring

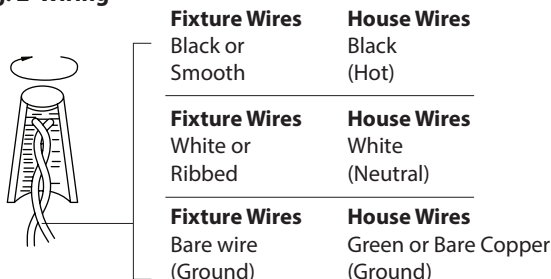

### Fig. 3 Sealing

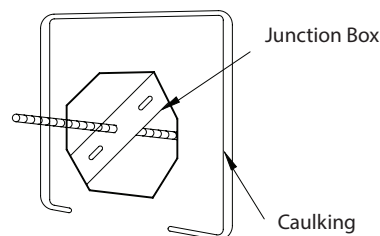

waclighting.com  
Phone (800) 526.2588  
Fax (800) 526.2585

Headquarters/Eastern Distribution Center  
44 Harbor Park Drive  
Port Washington, NY 11050

Central Distribution Center  
1600 Distribution Ct  
Lithia Springs, GA 30122

Western Distribution Center  
1750 Archibald Avenue  
Ontario, CA 91760

